

Name: \_\_\_\_\_ ( )

Class: Primary 6 \_\_\_\_\_

**CHIJ ST NICHOLAS GIRLS' SCHOOL (PRIMARY)**



**Primary 6 Mathematics  
2019 Termly Assessment**

**26 February 2019**

|                    |           |
|--------------------|-----------|
| <b>Total Marks</b> | <b>55</b> |
|--------------------|-----------|

\_\_\_\_\_  
**Parent's/Guardian's Signature**

**Time : 1 hour 30 minutes**

**INSTRUCTIONS TO CANDIDATES**

Do not turn over this page until you are told to do so.

Follow all instructions carefully.

Answer all questions.

Write your answers in this booklet

The use of an approved calculator is expected, where appropriate.

This booklet consists of 16 printed pages.

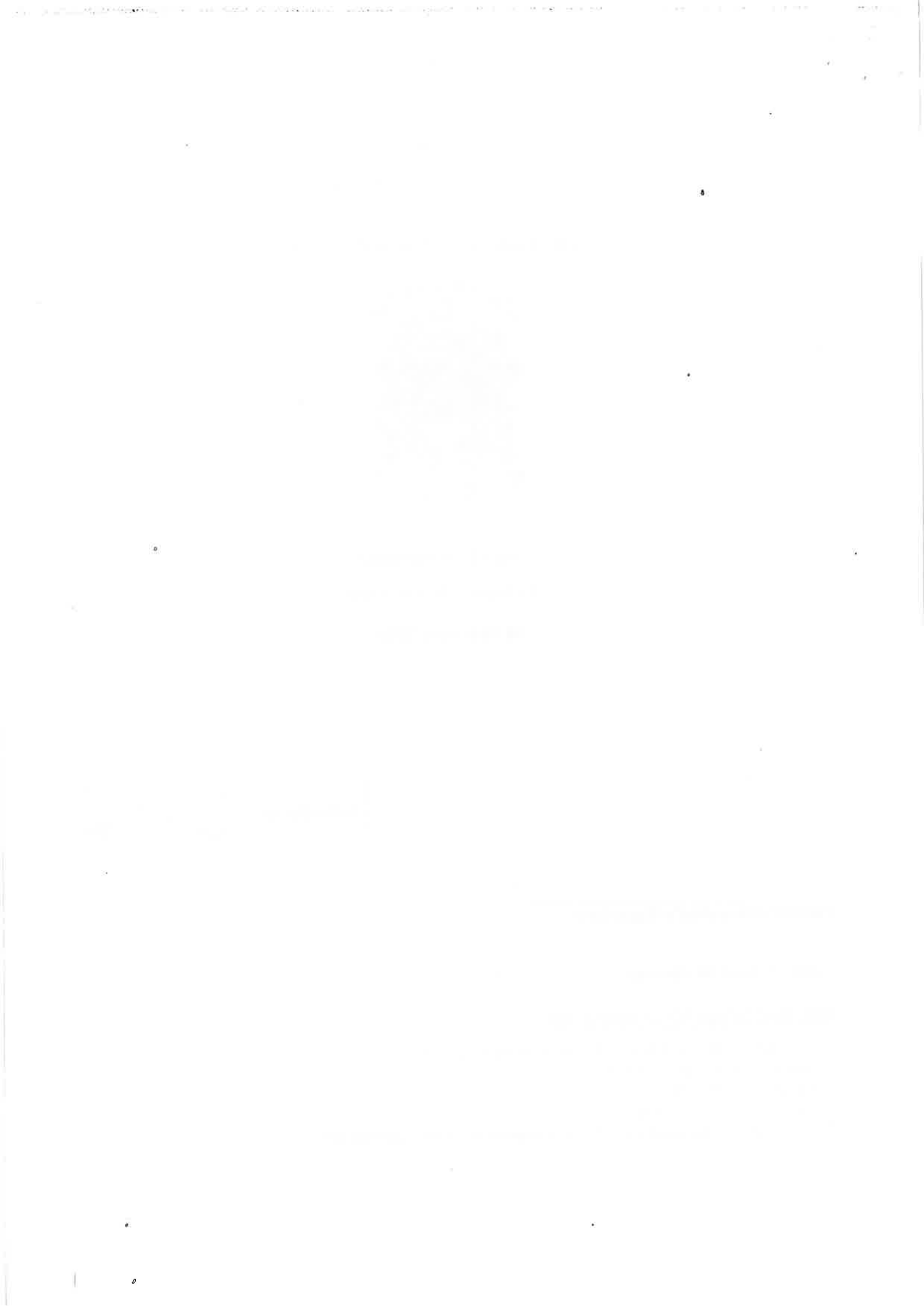

Questions 1 to 5 carry 2 marks each. Show your working clearly and write your answers in the spaces provided. For questions which require units, give your answers in the units stated.

(10 marks)

Do not write in this space

- 
1. Azura has 473 marbles and Lillian has 259 marbles. How many marbles must Azura give to Lillian such that both of them will have the same number of marbles?

Ans : \_\_\_\_\_

2. Simplify  $(7x + 4 - 3x) + 6 \div 2$ .

Ans : \_\_\_\_\_

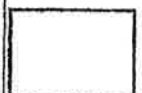

3. ABCD is a rhombus. Find  $\angle DAC$ .

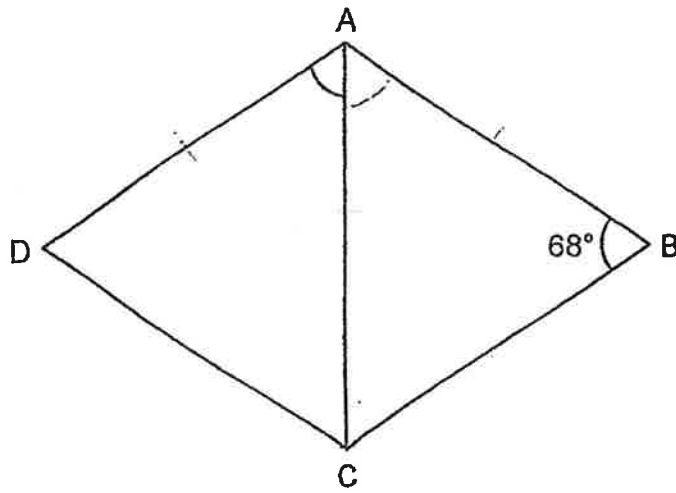

Ans : \_\_\_\_\_°

4. There are some triangles and circles. 4 circles are removed. What percentage of the remaining shapes are triangles? Round your answer to the nearest whole number.

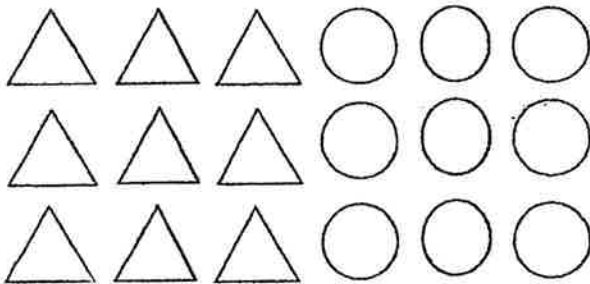

Ans : \_\_\_\_\_%

Do not write in this space



5. The figure below is made up of 3 triangles; ADE, BCE and CDE. ADC and BCD are 2 identical right-angled triangles. Point E is the midpoint of Line AC and Line BD.

Do not write in this space

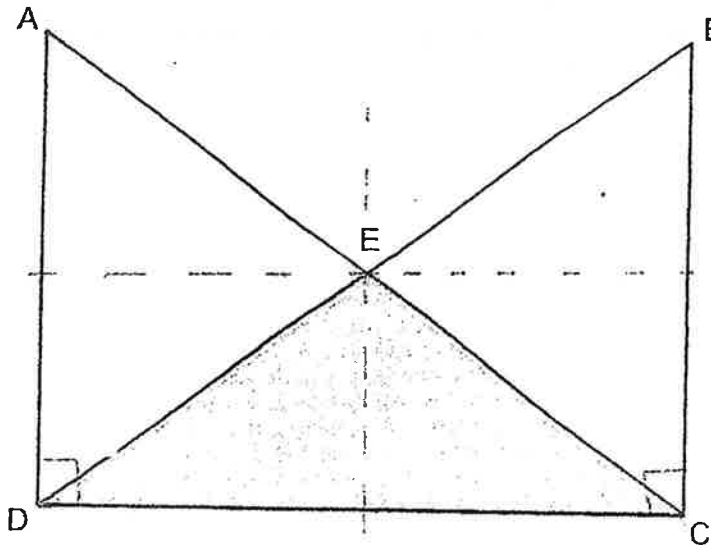

Each statement below is either true, false or not possible to tell from the information given. For each statement, put a tick (✓) in the correct column.

| Statement  | True | False | Not possible to tell |
|--|------|-------|----------------------|
| In Triangle BCE, BC is the base and BE is the height.                      |      |       |                      |
| The area of Triangle CDE is $\frac{1}{3}$ of the area of the whole figure. |      |       |                      |

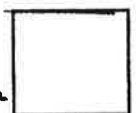

For questions 6 to 17, show your working clearly and write your answers in the spaces provided. The number of marks available is shown in the brackets ( ) at the end of each question or part-question. (45 marks)

Do not write this space

6. The average English score of a group of 12 pupils was 78. When 3 pupils left the group, the average score of the remaining pupils became 82. What was the total English score of the 3 pupils who left?

Ans : \_\_\_\_\_ [3]

7. The total mass of Alvin, Brian and Calvin is  $(4n + 9)$  kg. The mass of Alvin is  $2n$  kg and the mass of Brian is half of Alvin's.

(a) What is the mass of Calvin? Give your answer in terms of  $n$ .

(b) Given  $n = 35$ , what is the mass of Calvin?

Do not  
write in  
this  
space

Ans : (a) \_\_\_\_\_ [2]

(b) \_\_\_\_\_ [1]

8. Samuel baked some muffins. He sold  $\frac{1}{3}$  of them in the morning and  $\frac{4}{9}$  of them in the afternoon. He had 36 muffins left. How many muffins did Samuel bake?

Do not write in this space

Ans : \_\_\_\_\_ [3]



9. Ali wanted to return a book that was overdue for 6 days. The overdue charges for each book are shown in the table below.

Do not  
write in  
this  
space

| Overdue charges per book |                |
|--------------------------|----------------|
| No. of days overdue      | Charges        |
| First 5 days             | \$0.15 per day |
| Every additional day     | \$0.35 per day |

Ali had only \$0.85. How much more did he need to pay for the overdue charges?

Ans : \_\_\_\_\_ [3]

10. The ratio of the number of twenty-cent coins to the number of one-dollar coins in a box is 9 : 5. There are 104 more twenty-cent coins than one-dollar coins. What is the difference between the value of the twenty-cent coins and the one-dollar coins?

Do not write in this space

Ans : \_\_\_\_\_ [4]

11. The figure below shows a rectangle.  $ABC$  is an equilateral triangle.

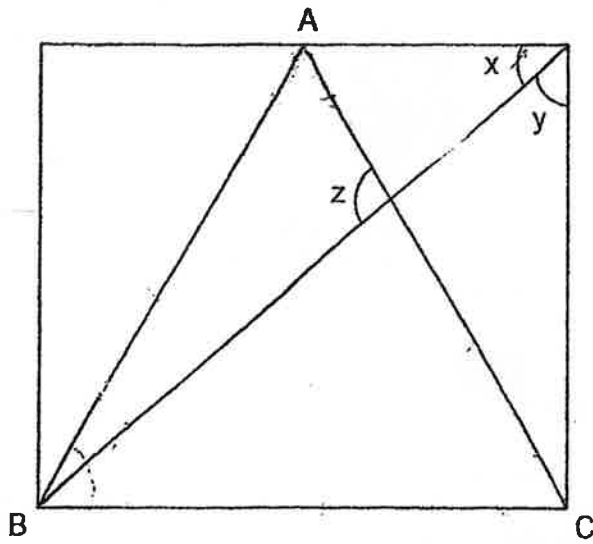

The ratio of  $\angle x$  to  $\angle y$  is,  $4 : 5$ . Find the value of  $\angle z$ .

Do not  
write in  
this  
space

Ans : \_\_\_\_\_ [3]

12. Mrs Ng wants to buy the following three toys for her children for Christmas.

Do not  
write in  
this  
space

The diagram illustrates three toys and their pricing. On the left, three toy blocks are shown with letters 'A', 'B', and '3' on their faces. A starburst above them says 'Promotional item'. Below them is a box containing 'Toy Blocks' and 'Promotional Price: \$35'. In the center, a teddy bear is shown. A starburst above it says 'Promotional item'. Below it is a box containing 'Teddy Bear' and 'Promotional Price: \$9'. At the bottom, a toy train is shown. Below it is a box containing 'Toy Train' and 'Usual Price: \$55'.

She has two options for her purchase.

Option 1:

Use her membership card and get a 15% discount on items that are not on promotion.

Option 2:

Use a \$10 discount voucher to get \$10 off her total purchase.

Which option should she choose if she wants to enjoy more savings? How much more savings would she enjoy if she chooses that option?

Ans : Option \_\_\_\_\_ [2]

Savings: \_\_\_\_\_ [1]

13. Water flowed from a tap at the same rate into a rectangular tank measuring 50 cm by 38 cm by 65 cm. At 6 p.m., the height of the water in the tank was 13 cm. At 6.30 p.m., it was  $\frac{1}{2}$  filled with water. How much water flowed into the tank in one minute?

Do not write in this space

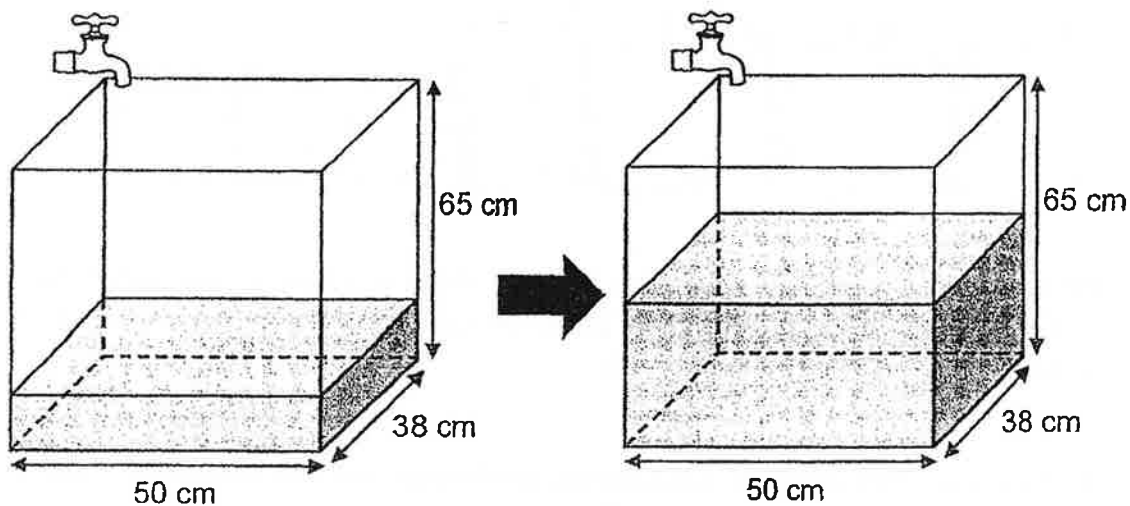

Ans : \_\_\_\_\_ [4]



14. Sulyn filled two types of pails, large and small, with some red paint that she had bought. She filled 3 identical large pails and 4 identical small pails to the brim with 10.1 ℓ of red paint.

Do not  
write  
this  
space

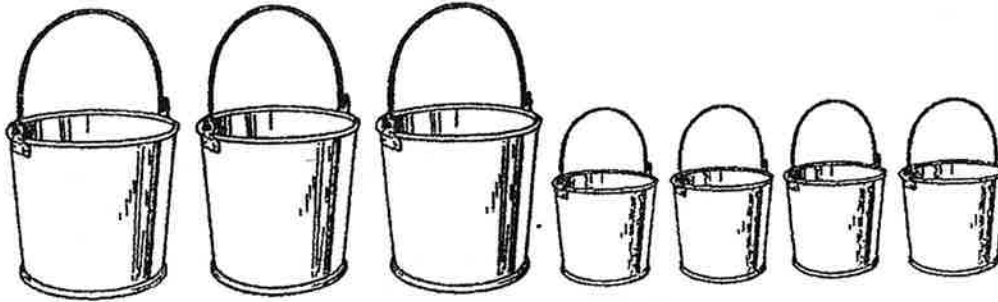

She could not fill another large pail to the brim with the remaining amount of red paint as she was short of 0.3 ℓ of red paint. Hence, she filled another small pail to the brim and had 0.5 ℓ of red paint left.

- (a) How many more litres of red paint can each large pail hold than each small pail?
- (b) How many litres of red paint did Sulyn buy?

Ans : (a) \_\_\_\_\_ [1]

(b) \_\_\_\_\_ [3]

15. A wooden path of length 19.8 m is completely covered with similar wooden planks, following the pattern shown below. The width of the path is 110 cm.

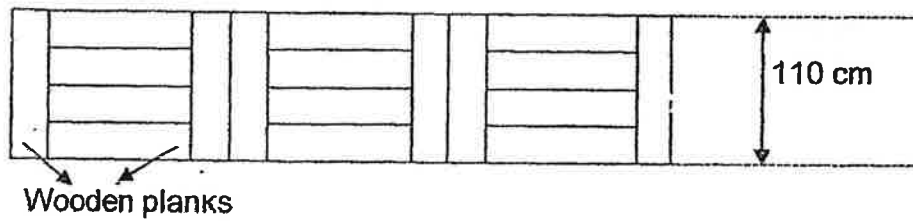

Do not  
write in  
this  
space

- (a) What is the breadth of each wooden plank?
- (b) How many wooden planks were used to cover the entire path?

Ans : (a) \_\_\_\_\_ [1]

(b) \_\_\_\_\_ [4]

16. Nuts were sold at \$8 per kilogram. Mrs Ho spent some money to buy some nuts. She gave  $2\frac{1}{2}$  kg of nuts to her neighbours and  $\frac{1}{5}$  of the remainder to her son. She gave the rest of the nuts equally to her 3 daughters. Each daughter received 1 kg of nuts. How much did Mrs Ho spend to buy the nuts?

Do not  
write in  
this  
space

Ans : \_\_\_\_\_ [5]



17. Ping Ting draws some triangles that follow a pattern. The first four figures are shown below.

Do not write in this space



Figure 1

Figure 2

Figure 3

Figure 4

(a) Study the pattern and complete the table below.

| Figure Number | Number of shaded triangles | Number of unshaded triangles | Total number of triangles |
|---------------|----------------------------|------------------------------|---------------------------|
| 1             | 1                          | 0                            | 1                         |
| 2             | 3                          | 1                            | 4                         |
| 3             | 6                          | 3                            | 9                         |
| 4             | 10                         | 6                            | 16                        |
| 5             | _____                      | _____                        | _____                     |

[1]

(b) What is the total number of triangles in Figure 17?

(c) How many unshaded triangles will there be in Figure 25?

Ans : (b) \_\_\_\_\_ [2]

(c) \_\_\_\_\_ [2]

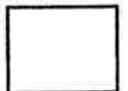

\*\*End of Paper\*\*



# ANSWER KEY

YEAR : 2019  
 LEVEL : PRIMARY 6  
 SCHOOL : CHIJ ST NICHOLAS GIRLS' SCHOOL (PRIMARY)  
 SUBJECT : MATHEMATICS  
 TERM : CA1



|     |  |
|-----|--|
| Q1  | $473 - 259 = 214$<br>$214 \div 2 = 107$<br>Ans $\rightarrow$ 107 marbles   |
| Q2  | $(7x + 4 - 3x) + 6 \div 2$<br>$= (4x + 4) + 3$<br>$= 4x + 7$<br>Ans $\rightarrow$ $4x + 7$   |
| Q3  | $180 - 68 = 112$<br>$112 \div 2 = 56$<br>Ans $\rightarrow$ $56^\circ$  |
| Q4  | Triangle : Shape $\rightarrow$ 9 : 5<br>$\frac{9}{14} \times 100\% = 64\frac{2}{7}$<br>Ans $\rightarrow$ 64%   |
| Q5  | (a) False<br>(b) Not possible to tell $\rightarrow$ Base and height might different length.  |
| Q6  | Total of 12 pupils $\rightarrow 12 \times 78 = 936$<br>Total of 9 pupils $\rightarrow 9 \times 82 = 738$<br>$936 - 738 = 198$  |
| Q7  | A $\rightarrow 2n$<br>B $\rightarrow 2n \div 2 = n$<br>C $\rightarrow 4n + 9 - 2n - 1n = n + 9$<br>(a) $(n + 9)$ kg<br>(b) $35 + 9 = 44$ kg  |
| Q8  | $1 - \frac{1}{3} - \frac{4}{9} = \frac{9}{9} - \frac{3}{9} - \frac{4}{9} = \frac{2}{9}$<br>$36 \div 2 \times 9 = 162$<br>Ans $\rightarrow$ 162 muffins   |
| Q9  | $0.15 \times 5 = 0.75$<br>$0.75 + 0.35 = 1.10$<br>$1.10 - 0.85 = \$0.25$   |
| Q10 | $104 = 9u - 5u$<br>$4u = 104$<br>$u = 104 \div 4 = 26$<br>For twenty-cent coins,<br>$26 \times 9 = 234$<br>$234 \times 0.20 = 46.80$<br>For one-dollar coins.<br>$5 \times 26 = 130$<br>$130.00 - 46.80 = \$83.20$ |

|     |  |
|-----|--|
| Q11 | $\angle x : \angle y = 4 : 5$ (total of $90^\circ$ )<br>$\angle x = 40^\circ ; \angle y = 50^\circ$<br>$\angle xBC = 40^\circ$<br>$\angle Abx = 60^\circ - 40^\circ = 20^\circ$<br>$\angle z = 180^\circ - 60^\circ - 20^\circ = 100^\circ$<br><b>Ans <math>\rightarrow 100^\circ</math></b>                           |
| Q12 | Option 1,<br>$\frac{85}{100} \times 55 = 46.75$<br>$46.75 + 35 + 9 = \$90.75$<br>Option 2,<br>$35 + 9 + 55 - 10 = \$89$<br><b>Ans(a) <math>\rightarrow</math> Option 2</b><br>$\$90.75 - \$89.00 = \$1.75$<br><b>Ans (b) <math>\rightarrow</math> \$1.75</b>   |
| Q13 | <b>6.00pm</b><br>$50 \times 38 \times 13 = 24700$<br><b>6.30pm</b><br>$65 \div 2 = 32.5$<br>$50 \times 38 \times 32.5 = 61750$<br>$61750 - 24700 = 37050$<br>$37050 \div 30 = 1235$<br><b>Ans <math>\rightarrow 1235\text{ml}</math></b>   |
| Q14 | $0.5 + 0.3 = 0.8$<br><b>Ans (a) <math>\rightarrow 0.8\text{L}</math></b><br>$0.8 \times 3 = 2.4$<br>$10.1 - 2.4 = 7.7$<br>$4 \times 3 = 7$<br>$7.7 \div 7 = 1.1$ (Small pail)<br>$1.1 + 0.5 = 1.6$ (extra)<br>$10.1 + 1.6 = 11.7$<br><b>Ans (b) <math>\rightarrow 11.7\text{L}</math></b>                              |
| Q15 | $110 \div 4 = 27.5$<br><b>Ans (a) <math>\rightarrow 27.5\text{cm}</math></b><br>$27.5 \times 2 + 110 = 165$<br>$19.8\text{m} = 1980\text{cm}$<br>$1980 \div 165 = 12$<br>$12 \times 6 = 72$<br><b>Ans (b) <math>\rightarrow 72</math> planks</b>   |
| Q16 | $\$8 \times 3 = \$24$<br>$\$24 \div 4 \times 5 = \$30$<br>$2\frac{1}{2} \text{kg} \times \$8 = \$20$<br>$\$30 + \$20 = \$50$<br><b>Ans <math>\rightarrow 50</math></b>   |
| Q17 | <b>(a) 15 , 10 , 25</b><br><b>(b) <math>17 \times 17 = 289</math></b><br><b>(c) <math>1 + 2 + \dots + 24 = 24 \times (\text{median} + 0.5)</math> {For eg, <math>1 + 2 + 3 = 3 \times 2</math>}</b><br>$= 24 \times 12.5 = 300$ <span style="float: right;">{For eg, <math>1 + 2 + 3 + 4 = 4 \times 2.5</math>}</span> |

