



**RAFFLES GIRLS' PRIMARY SCHOOL
PRELIMINARY EXAMINATION
MATHEMATICS (PAPER 1)
PRIMARY 6**

Name: _____ ()

Form Class: P6 _____

Math Teacher :

Date: 19 Aug 2020

Duration: 1 hour

Your Paper 1 Score (Out of 45 marks)	
Your Paper 2 Score (Out of 55 marks)	
Your Total Score (Out of 100 marks)	
Parent's Signature	

INSTRUCTIONS TO CANDIDATES

1. Do not turn over this page until you are told to do so.
2. Follow all instructions carefully.
3. Answer **ALL** questions and show all working clearly.
4. **NO** calculator is allowed for this paper.

Questions 1 to 10 carry 1 mark each. Questions 11 to 15 carry 2 marks each.
For each question, four options are given. One of them is the correct answer.
Make your choice (1, 2, 3 or 4). Shade your answer (1, 2, 3 or 4) on the OAS provided.
All diagrams are not drawn to scale. (20 marks)

1. The value of the digit 5 in 954 687 is _____.

- (1) 500
- (2) 5000
- (3) 50 000
- (4) 500 000

2. Which one of the following is closest to 1?

- (1) $1\frac{1}{7}$
- (2) $1\frac{1}{6}$
- (3) $1\frac{1}{9}$
- (4) $1\frac{1}{8}$

3. Round off 28 784 to the nearest tenth.

- (1) 28.7
- (2) 28.8
- (3) 29.0
- (4) 30.0

4. What is the length of the screw driver?

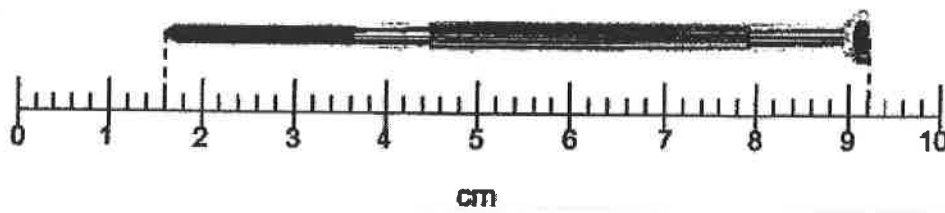

- (1) 7.3 cm
- (2) 7.6 cm
- (3) 9.1 cm
- (4) 9.2 cm

5. In the figure, ABC is an equilateral triangle. CDE is an isosceles triangle. BCE is a straight line. $\angle CDE = 69^\circ$. Find the sum of $\angle BCD$ and $\angle ACE$.

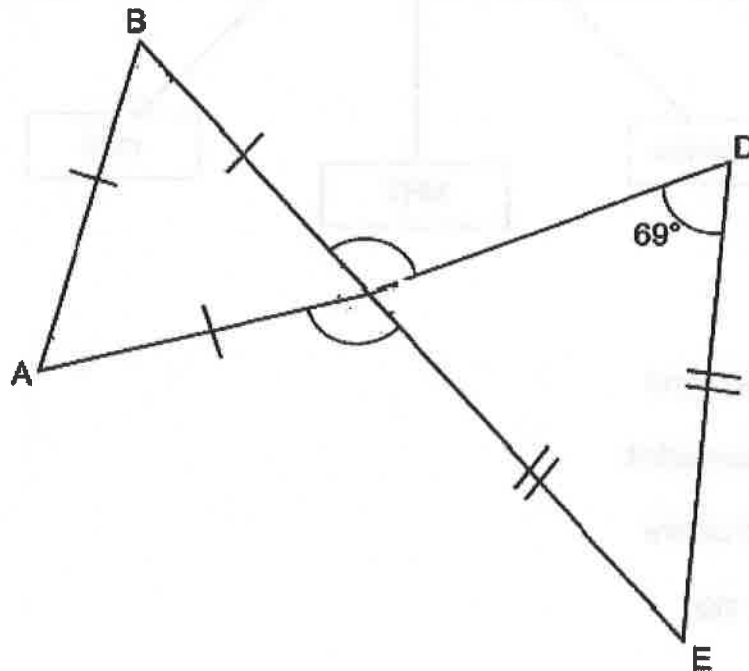

- (1) 129°
- (2) 222°
- (3) 231°
- (4) 240°

6. Gordon was at the park. He turned an angle of 315° anti-clockwise to face the direction of his home. Where was he facing before the turn?

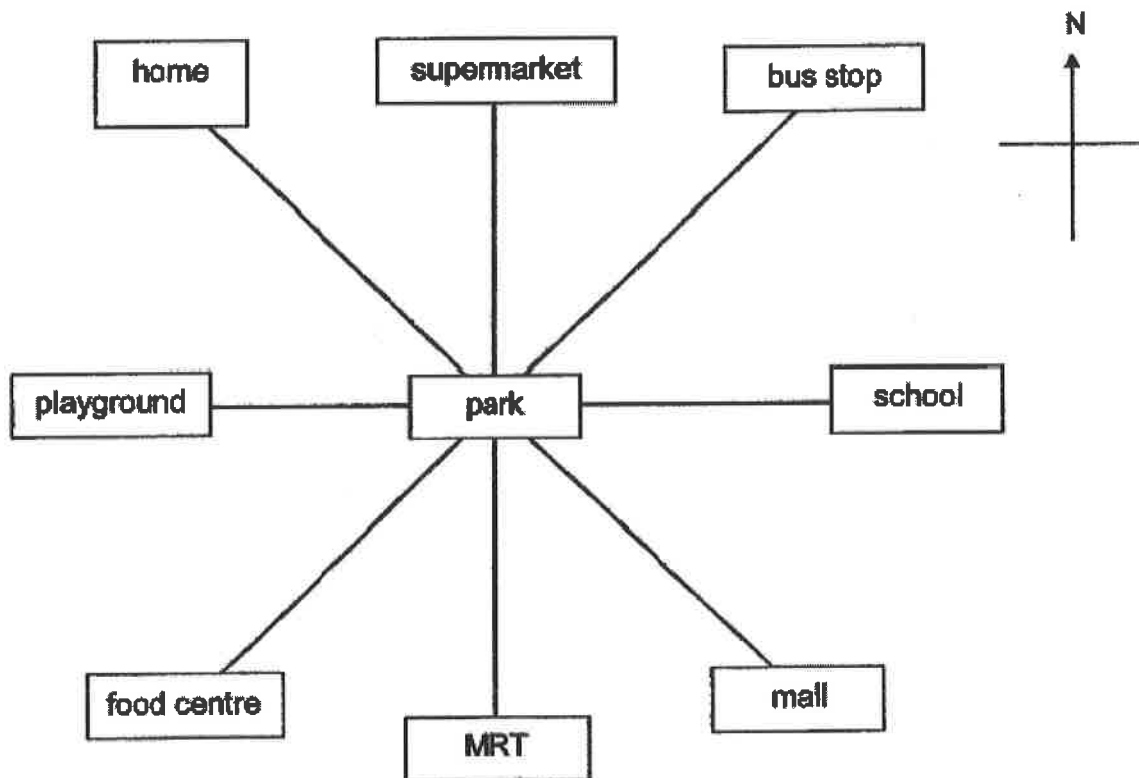

- (1) playground
- (2) supermarket
- (3) food centre
- (4) bus stop

7. The figure is made up of 2 squares. The area of the 2 squares are 64 cm^2 and 25 cm^2 . What is the perimeter of the figure?

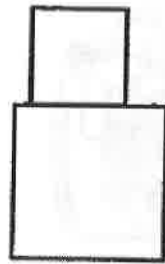

- (1) 42 cm
(2) 47 cm
(3) 52 cm
(4) 89 cm
8. Abel had 3 times as many books as Thomas. Abel donated $\frac{1}{4}$ of his books to charity. What was the ratio of the number of books Thomas had to the number of books Abel had in the end?

- (1) 3 : 4
(2) 4 : 9
(3) 9 : 4
(4) 9 : 7

9. Calvin bought a camera. The GST amount was \$70. How much did he pay for the camera inclusive of GST?



- (1) \$107
(2) \$170
(3) \$1000
(4) \$1070
10. $3 + 6a = 27$. What is the value of a ?
- (1) 180
(2) 144
(3) 5
(4) 4
11. Ai Lin bought 2 tables and 20 chairs for her office. She spent \$120 more on the tables than the chairs. She spent a total of \$840. How much did she spend on one chair?
- (1) \$18
(2) \$24
(3) \$180
(4) \$360

12. $\frac{1}{2}$ of Janice's mass is the same as $\frac{1}{5}$ of Randy's mass.

Their total mass is 49.14 kg. Find Janice's mass.

- (1) 7.02 kg
- (2) 14.04 kg
- (3) 14.4 kg
- (4) 35.1 kg

13. A dining table was sold at a discount. The discounted price was 20% less than the usual price. The usual price was \$720. How much was the discount?

- (1) \$20
- (2) \$120
- (3) \$144
- (4) \$576

14. Ali and Zainal each bought the same mass of minced meat. They prepared each patty with the same mass of minced meat. Ali made 20 patties and had 5.6 kg of minced meat left. Zainal made 60 patties and had 400 g of minced meat left. What was the mass of minced meat used for each patty?

- (1) 65 g
- (2) 75 g
- (3) 130 g
- (4) 150 g

15. Tap A can fill a pail in 6 min. Tap B can fill the same pail in 3 min. How long would it take to fill the pail completely when both taps are turned on at the same time?
- (1) 0.5 min
 - (2) 2 min
 - (3) 4.5 min
 - (4) 9 min

Questions 16 to 20 carry 1 mark each. Write your answers in the spaces provided.
For questions which require units, give your answers in the units stated. All diagrams
are not drawn to scale. (5 marks)

16. Find the value of $50 - (24 + 2 \times 3) + 4$.

Ans: _____

17. When a flight departed from Singapore, the time in Perth was 8.50 p.m.
The flight arrived in Perth 5 h 15 min later. At what time in Perth did the
flight arrive? Give your answer in 24-hour clock.

Ans: _____

18. Express $\frac{78}{9}$ as a mixed number in the simplest form.

Ans: _____

19. Find the sum of 11 tens, 1 tenth and 10 hundredths.

Ans: _____

20. Find the average of 180 cm and 1.2 m. Leave your answer in metres.

Ans: _____ m

Questions 21 to 30 carry 2 marks each. Show your working clearly in the space provided for each question and write your answers in the spaces provided. For questions which require units, give your answers in the units stated. All diagrams are not drawn to scale. (20 marks)

21. Pillai mixed milk and rose syrup to make a drink. He used $\frac{7}{8}$ ℓ of milk. The amount of rose syrup used was $\frac{1}{6}$ ℓ less than the milk used. How much milk and rose syrup did Pillai use altogether? Leave your answer as a mixed number in the simplest form.

Ans: _____ ℓ

22. Alex has a box measuring 40 cm by 50 cm by 60 cm. He wants to pack identical rubik's cubes of edge 6 cm into the box. What is the maximum number of rubik's cubes he can pack into the box?

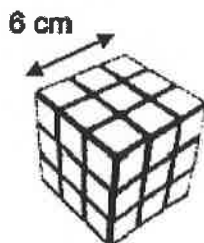

Ans: _____

23. Mrs Delvi had $24n$ cookies. She distributed all of them equally to 8 of her grandchildren. Then, one of her grandchildren, Heidi, ate 4 cookies. How many cookies had Heidi left? Leave your answer in terms of n .

Ans: _____

24. There were equal number of male and female members at a gym. After 265 male members and 545 female members cancelled their gym membership, the number of remaining male members was 9 times that of the remaining female members. How many female members remained at the gym?

Ans: _____

25. In the figure, ABCD is a rectangle and AEFG is a rhombus.

AHF is a straight line and $\angle BAE = 22^\circ$. Find $\angle CHF$.

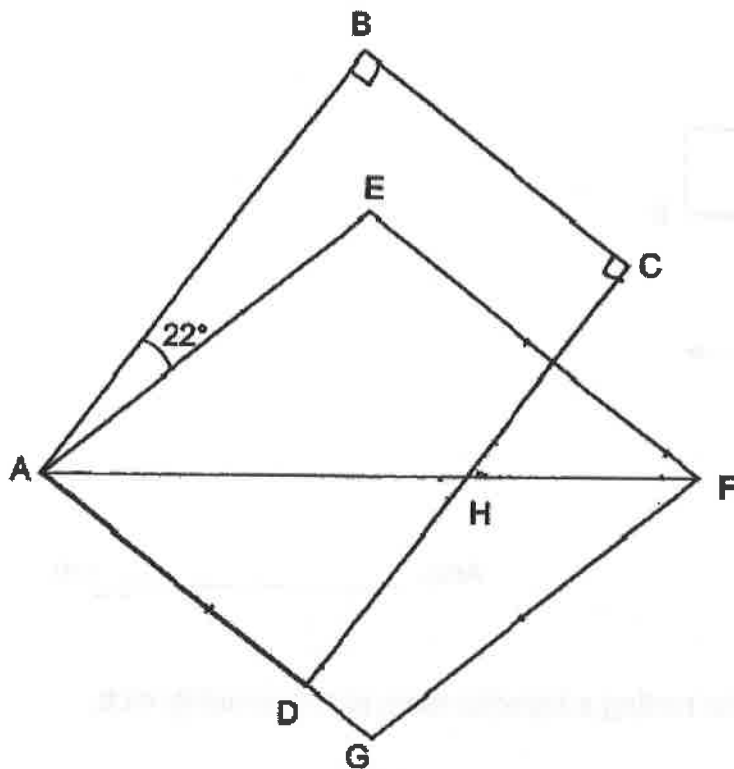

Ans: _____°

26. Anna needed 20 pieces of wires, each of length 0.3 m. The wires were sold in rolls of 2 m each. What was the least number of rolls of wire that Anna needed to buy?

Ans: _____

27. The figure is made up of 3 squares. AB is a straight line. What is the perimeter of the figure?

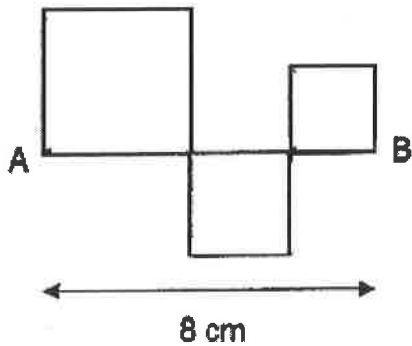

Ans: _____ cm

28. The table shows the rate for renting a karaoke room at a community club.

First 2 hours	\$9 per hour
Every additional 30 min	\$8 per 30 min

A group of friends paid a total of \$42 for the rental of a karaoke room.
How many hours did they rent the karaoke room for?

Ans: _____ h

29. Sara had $\frac{5}{6}$ m² of fabric. She cut out $\frac{1}{4}$ of it and used the remaining fabric to make 5 identical masks. How much fabric did she use to make 1 mask?

Ans: _____ m²

30. The graph shows the number of houses sold from January to March. The bar for the number of houses sold in March has not been drawn.

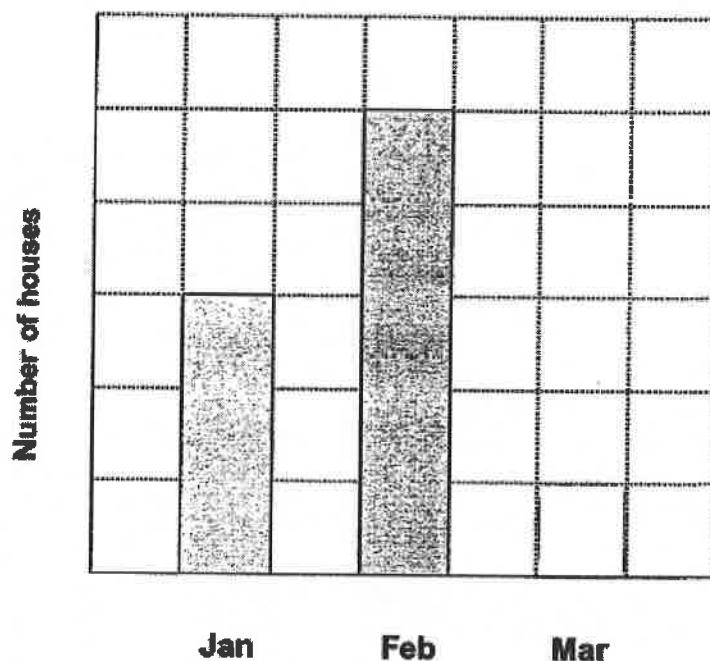

The total number of houses sold in February and March was $\frac{2}{3}$ of the total number of houses sold over the 3 months.

Complete the graph by shading to show the number of houses sold in March.

End of Paper
Please check your work carefully ☺



**RAFFLES GIRLS' PRIMARY SCHOOL
PRELIMINARY EXAMINATION
MATHEMATICS (PAPER 2)
PRIMARY 6**

Name: _____ ()

Form class: P6 _____

Math Teacher :

Date: 19 Aug 2020

Duration: 1 h 30 min

INSTRUCTIONS TO CANDIDATES

1. Do not turn over this page until you are told to do so.
2. Follow all instructions carefully.
3. Answer **ALL** questions and show all working clearly.
4. The use of calculator is allowed for this paper.

Questions 1 to 5 carry 2 marks each. Show your working clearly in the space provided for each question and write your answers in the spaces provided.

For questions which require units, give your answers in the units stated.

All diagrams are not drawn to scale.

(10 marks)

-
1. There were 538 females and 306 males at a carnival. 110 females left and 25 males entered the carnival. What was the percentage decrease in the total number of people at the carnival? Round your answer to the nearest 1 decimal place.

Ans : _____ %

2. The table shows the points scored by 3 children in a game.

Participants	Ali	Bala	Charlie
Score	21	?	?

Their total score was 135. All their scores were 2-digit numbers. What was the lowest possible score among the 3 of them?

Ans: _____

3. In the square grid, AB and BC form two sides of a trapezium ABCD.
 There are 2 right angles in ABCD.
 Complete the drawing of trapezium ABCD.

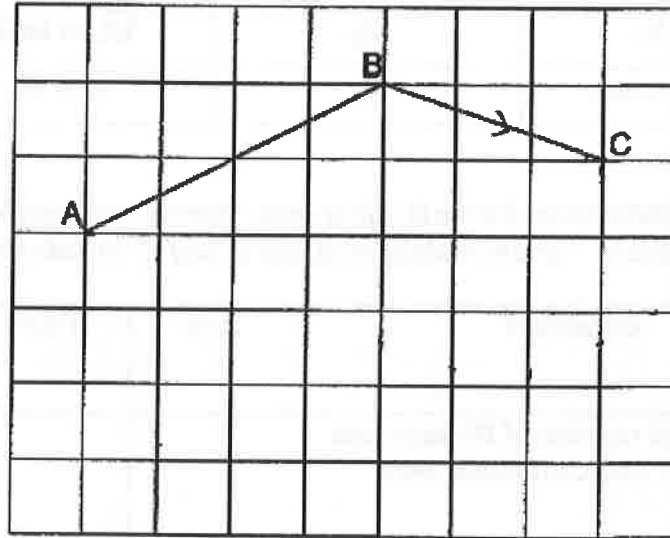

4. Amos is 12 years younger than his sister. The ratio of Amos' age to his sister's age is 1 : 5. In how many years' time will the ratio of Amos' age to his sister's age be 2 : 5?

Ans : _____ years

5. The table shows the number and the cost of each type of flowers sold at a florist.

Flower	Number of flowers sold	Cost
Rose	135	\$2 each
Lily	2y	\$2.50 each
Carnation	4y	4 for \$5

Each of the statements below is either true, false or not possible to tell from the information given. For each statement, put a tick(✓) to indicate your answer.

Statement	True	False	Not possible to tell
(a) If the total number of flowers sold was 405, 180 carnations were sold.			
(b) The amount of money collected from selling the lilies and the carnations were the same.			
(c) The amount of money collected from selling the roses was the highest among the 3 types of flowers.			

For questions 6 to 17, show your working clearly in the space provided for each question and write your answers in the spaces provided. The number of marks available is shown in the brackets [] at the end of each question or part-question. All diagrams are not drawn to scale. (45 marks)

6. The bar chart shows the height of 6 people. The bar that shows Peggy's height has not been drawn.

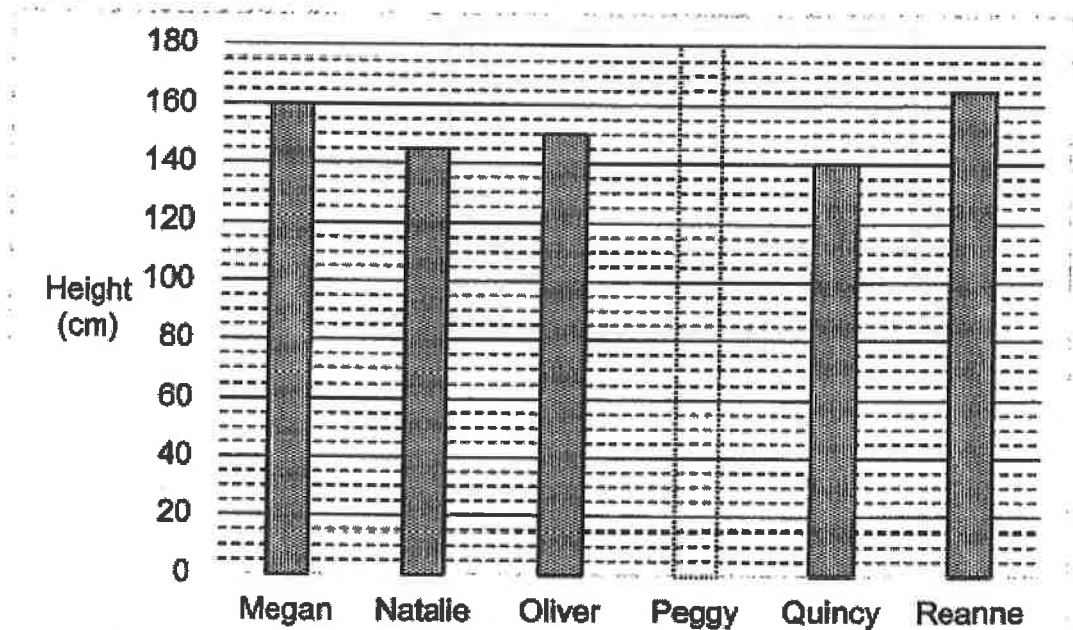

Peggy's height was 20 cm more than the average height of Quincy and Megan.

- (a) What was the height of Peggy?
 (b) Who was/were taller than the average height of all the people?

Ans: (a) _____ [2]

Ans: (b) _____ [2]

7. A rectangular tank measuring 45 cm by 16 cm by 25 cm was $\frac{1}{3}$ filled with water. After water from some identical bottles was poured into the rectangular tank, it became $\frac{7}{8}$ full. The capacity of each bottle was 650 ml. What was the minimum number of bottles used to pour the water into the rectangular tank?

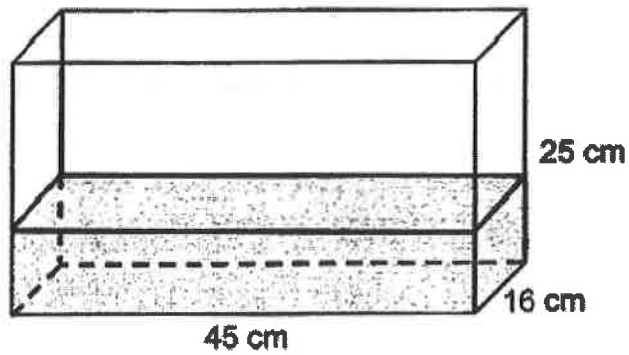

Ans: _____ [3]

8. Mr Choo needs a total of 15 h to prepare 1800 rice dumplings. He prepares the same number of rice dumplings every hour. When his wife helps him for 4 h, 1800 rice dumplings can be prepared in 9 h.

(a) What is the average number of rice dumplings that Mr Choo's wife prepares in the 4 hours?

(b) What is the difference in the time taken between Mr Choo and his wife if she prepares 1800 rice dumplings alone?

Ans: (a) _____ [2]

(b) _____ [2]

9. At its year-end sale, a company sold calendars and diaries at the prices shown.

Year-End Clearance Sale



Calendars
6 for \$37



Diaries
8 for \$99

An equal number of calendars and diaries were sold. The company collected a total of \$29 815 from the sale of calendars and diaries. How many calendars and diaries did the company sell in all?

Ans: _____ [3]

10. In a school, 55% of the pupils are girls and the rest are boys. As a school, 40% of the boys wear spectacles and 60% of the pupils wear spectacles.

(a) What percentage of the pupils are girls who wear spectacles?

(b) 208 girls do not wear spectacles. How many pupils are there altogether?

Ans: (a) _____ [2]

(b) _____ [1]

11. The figure is formed by 3 identical big semicircles and 3 identical small semicircles.

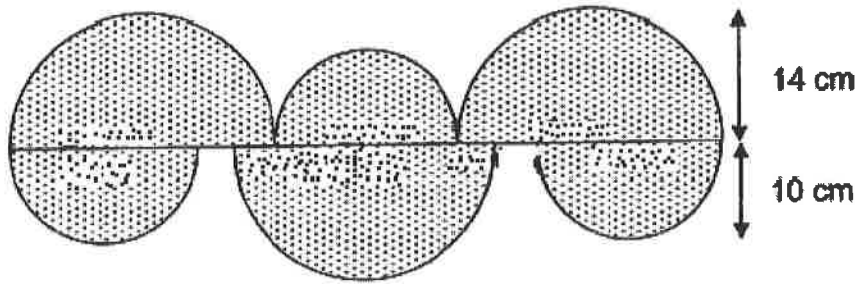

Use the calculator value of π to find the perimeter of the figure.
Round your answer to 2 decimal places.

Ans: _____ [3]

12. The figure shows a parallelogram PQRS drawn on a grid.

(a) PRTU is a rectangle that has half the area of PQRS.
Draw PRTU on the grid.

[2]

(b) PRV is an isosceles triangle that has the same area as rectangle PRTU.
Draw PRV on the grid such that it does not overlap with rectangle PRTU.

[1]

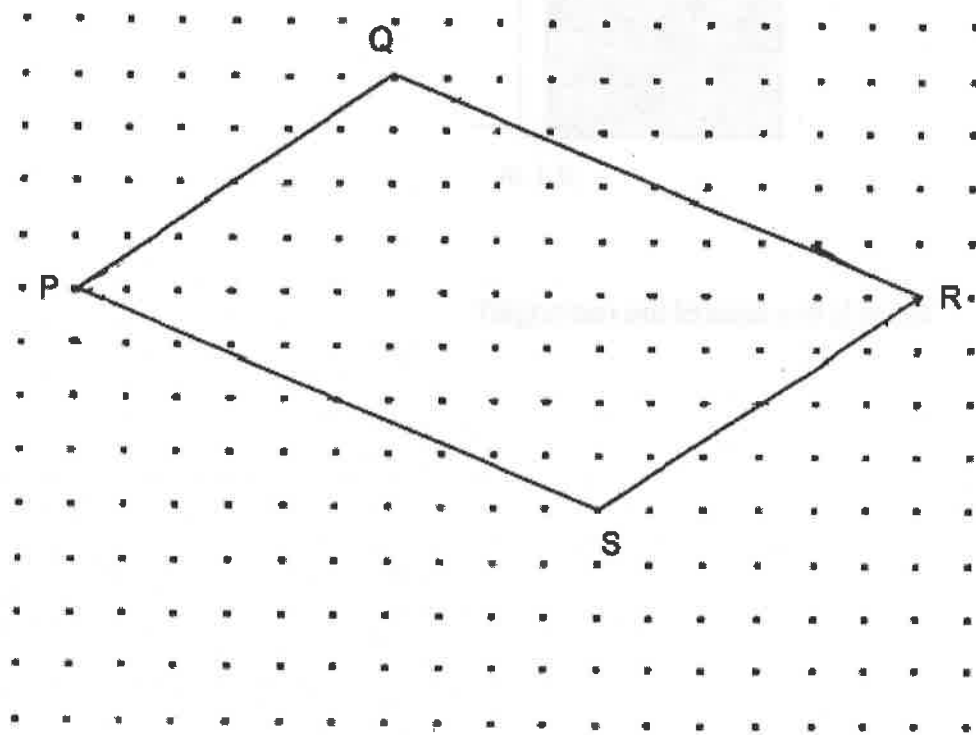

13. The figure shows 6 identical squares inside a rectangle. The arrangement results in a gap of 0.2 m at the top and a gap of 0.1 m at the side. The area of the unshaded region is 3000 cm^2 .

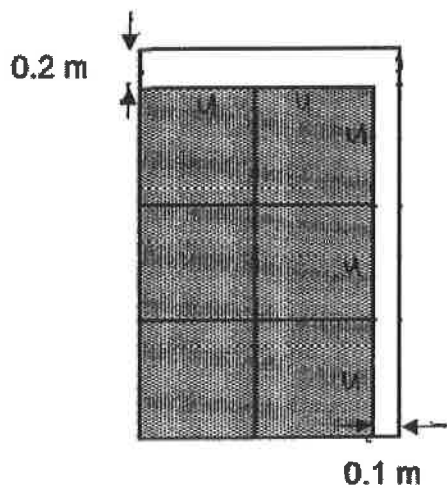

What is the area of the rectangle?

Ans: _____ [4]

14. A L-shaped paper is made up of perpendicular lines. It is folded along line AB as shown. $\angle CBD = 28^\circ$.

(a) Find $\angle x$.

(b) Find $\angle y$.

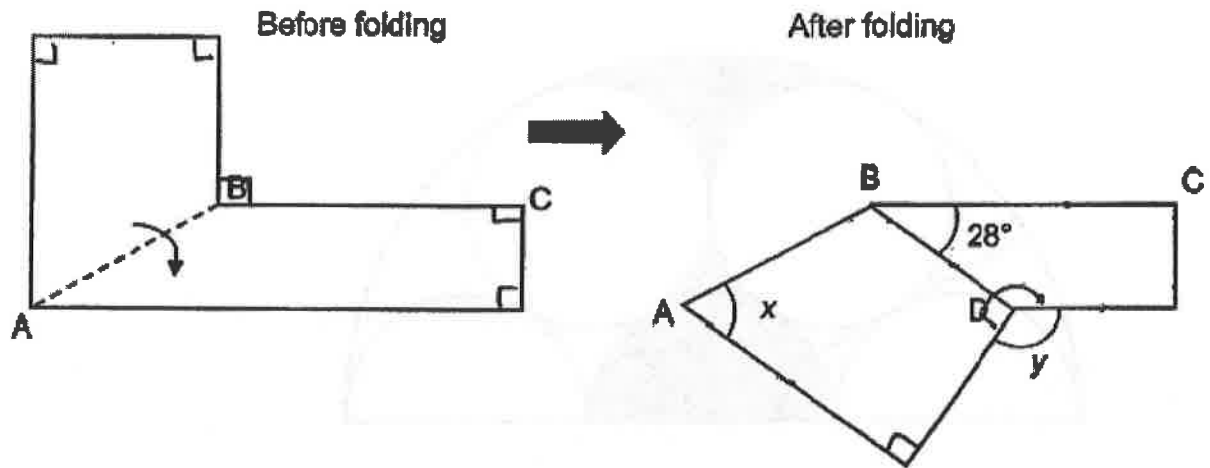

Ans: (a) _____ [2]

(b) _____ [2]

15. The figure is made up of a big semicircle of radius 30 cm. 2 circles and 3 semicircles of equal radius are drawn in the big semicircle.

(a) What is the radius of the circle?

(b) What is the area of the shaded parts? Take $\pi = 3.14$
Round your answer correct to 1 decimal place.

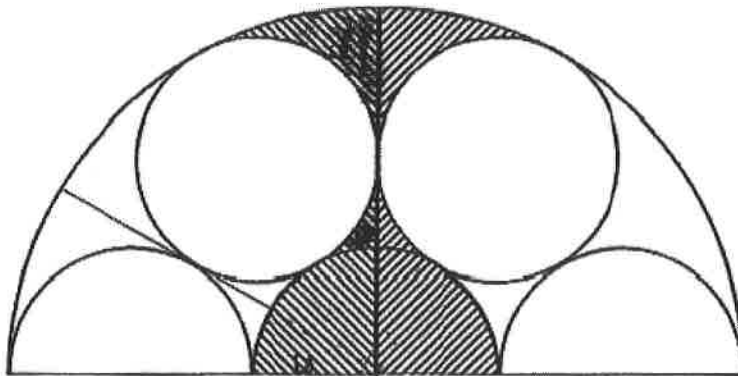

Ans: (a) _____ [1]

(b) _____ [3]

16. Mdm Nurul had some red and green apples in her minimart. The ratio of the number of red apples to the number of green apples was 13 : 7. After selling 60% of the red apples and 55 green apples, the ratio of the number of red apples to the number of green apples was 13 : 12.

(a) How many apples were there altogether at first?

(b) After that, she bought more red apples. The number of red apples she bought was $\frac{3}{10}$ of the number of red apples left before that. How many red apples did she have in the end?

Ans: (a) _____ [3]

(b) _____ [2]

17. Peter, Roger and Mary each had a sum of money. They decided to split their dinner bill equally.

If Roger were to pay for the bill first, the sum of his remaining money would be $\frac{4}{9}$ of Mary's money.

If Mary were to pay for the bill first, the sum of her remaining money would be $\frac{11}{15}$ of Roger's money.

If Peter were to pay for the bill first, he would have used up all his money.

- (a) Given that Mary had \$126 more than Roger, how much was each person's share of the bill?
- (b) Express Peter's sum of money as a fraction of their total sum of money

Ans: (a) _____ [4]

(b) _____ [1]

End of Paper
Please check your work carefully ☺

SCHOOL : RAFFLES GRILS' PRIMARY SCHOOL
 LEVEL : PRIMARY 6
 SUBJECT : MATH
 TERM : 2020 PRELIM

PAPER 1 BOOKLET A

Q 1	Q2	Q3	Q4	Q5	Q6	Q7	Q8	Q9	Q10
3	3	2	2	3	1	1	2	4	4

Q 11	Q12	Q13	Q14	Q15
1	2	3	3	2

PAPER 1 BOOKLET B

Q16)	$50 - 36 + 4 = 18$
Q17)	02 05
Q18)	$8\frac{2}{3}$
Q19)	$11 \times 10 = 110$ $10 \times 0.01 = 0.1$ $110 + 0.1 + 0.1 = 110.2$
Q20)	$1.2\text{m} \times 100 = 120\text{cm}$ $(180 + 120) \div 2 = 150$ $150\text{cm} = 1.5\text{m}$
Q21)	$M \rightarrow \frac{7}{8} \left(\frac{21}{24} \right)$ $R \rightarrow \frac{7}{8} - \frac{1}{6} = \frac{21}{24} - \frac{4}{24} = \frac{17}{24}$ $\text{Total} \rightarrow \frac{21}{24} + \frac{17}{24} = \frac{38}{24} = 1\frac{14}{24} = 1\frac{7}{12} \text{ } \ell$
Q22)	$40 \div 6 = (6) \text{ R}4$ $50 \div 6 = (8) \text{ R}2$ $60 \div 6 = (10)$ $6 \times 8 \times 10 = 480$



Q23)	$24u \div 8 = 3u$ $(3u - 4)\text{cookies}$
Q24)	$545 - 265 = 280$ $8u \rightarrow 280$ $u \rightarrow 280 \div 8 = 35$
Q25)	$(90 - 22) \div 2 = 34$ $180 - 90 - 34 = 56^\circ$
Q26)	$0.3 \times 100 = 30$ $2 \times 100 = 200$ $200 \div 3 = (6) \text{ R}20$ $20 \div 6 = (3) \text{ R}2$ $3 + 1 = 4$
Q27)	$4 \times 8 = 32\text{cm}$
Q28)	$1^{\text{st}} + 2^{\text{nd}} \text{ hr} \rightarrow \$9 \times 2 = \$18$ $\$42 - \$18 = \$24$ $\$24 \div \$8 = 3$ $3 \times 30 \text{ min} = 90 \text{ min}$ $= 1 \text{ h } 30 \text{ min}$ $1 \text{ h } 30\text{min} + 1 \text{ h} + 1 \text{ h} = 3 \text{ h } 30\text{min} = 3.5 \text{ h}$
Q29)	$\text{Left} \rightarrow \frac{5}{6} \times \frac{3}{4} = \frac{5}{8}$ $1 \text{ mask} \rightarrow \frac{5}{8} \div 5 = \frac{5}{8} \times \frac{1}{5} = \frac{1}{8} \text{ m}^2$
Q30)	$\text{Mar} = 1u$

PAPER 2

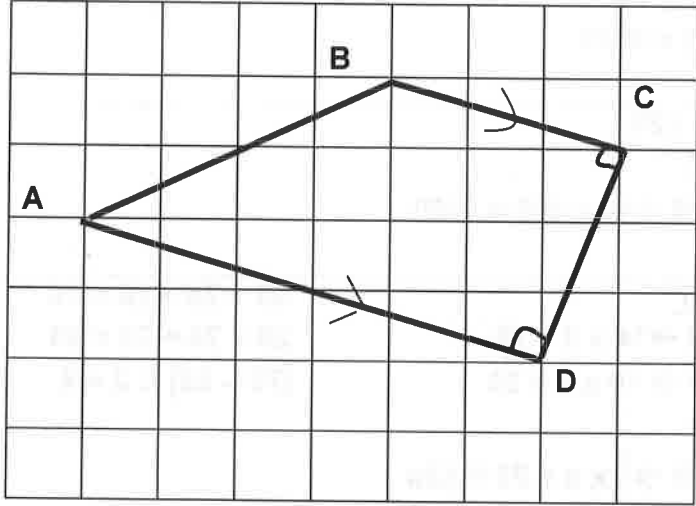
Q1)	$538 - 110 = 428$ $306 + 25 = 331$ $\text{Before} \rightarrow 538 + 306 = 844$ $\text{After} \rightarrow 428 + 331 = 759$ $844 - 759 = 85$ $\frac{85}{844} \times 100\% = 10.1\%$
-----	--

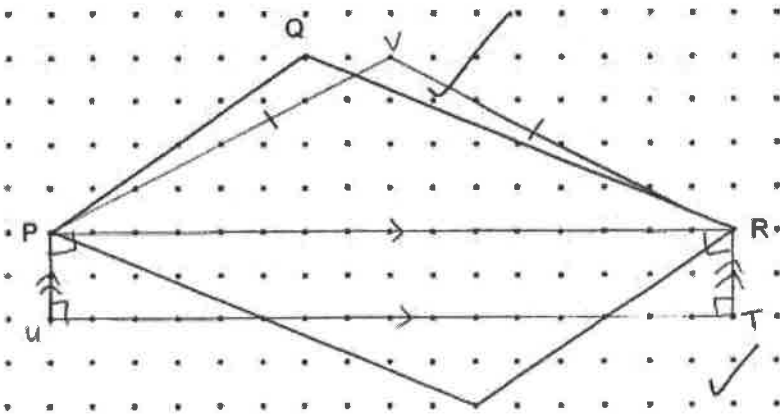
Q2)	$135 - 21 = 114$ $114 - 99 = 15$
Q3)	
Q4)	$15 - 3 = 12$ $12u \rightarrow 12$ $8 - 3 = 5$ $5u \rightarrow 12 \div 12 \times 5 = 5 \text{ years}$
Q5)	a) True b) True c) Not
Q6)	a) $(140 + 160) \div 2 = 150$ $150 + 20 = 170 \text{ cm}$ b) $(160 + 145 + 150 + 170 + 140 + 165) \div 6 = 155$ Megan , Peggy and Reanne
Q7)	$\frac{1}{3} \text{ full} \rightarrow (4 \times 16 \times 25) \div 3 = 6000$ $\frac{7}{8} \text{ full} \rightarrow (45 \times 16 \times 25) \div 8 \times 7 = 15750$ $15750 - 6000 = 9750$ $9750 \div 650 = 15$
Q8)	Mr $\rightarrow 1800 \div 15 = 120$ <u>9hrs</u> Mr $\rightarrow 120 \times 9 = 1080$ $1800 - 1080 = 720$ a) $720 \div 4 = 180$ b) $1800 \div 180 = 10$ $15 - 10 = 5 \text{ h}$

Q9)	$C \rightarrow 24 \div 6 \times 37 = 148$ $D \rightarrow 24 \div 8 \times 99 = 297$ $29815 \div (148 + 297) = 67$ $67 \times (24 \times 24) = 3216$
Q10)	a) $60 - 18 = 42\%$ b) $13u \rightarrow 208$ $100u \rightarrow 208 \div 13 \times 100 = 1600$
Q11)	<p><u>Diameter of</u> $28 + 20 + 28 = 76$</p> <p>Large semi $\rightarrow 14 \times 2 = 28$ $20 + 28 + 20 = 68$</p> <p>Small semi $\rightarrow 10 \times 2 = 20$ $(76 - 68) \div 2 = 4$</p> <p>Perimeter of $\rightarrow \frac{3}{2} \times \pi \times 28 = 42\pi$</p> <p>$\rightarrow \frac{3}{2} \times \pi \times 20 = 30\pi$</p> <p>$\rightarrow 4 + 4 = 8$</p> <p>Total $\rightarrow 42\pi + 30\pi + 8 \approx 234.19\text{cm}$</p>
Q12)	
Q13)	$a \rightarrow (2x) \times 20 + (10 \times 20) = 40 \times 200$ $b \rightarrow (3x) \times 10 = 30x$ $70x + 200 = 3000$ $X \rightarrow (3000 - 200) \div 70 = 40$ $3x \rightarrow 40 \times 3 = 120$ $2x \rightarrow 40 \times 2 = 80$ $(120 + 20) \times (80 + 10) = 12600\text{cm}^2$

Q14)	<p>a) $360 - 90 = 152$ $(270 - 28) \div 2 = 121$ $180 - 121 = 59^\circ$</p> <p>b) $180 - 28 - 152$ $360 - 152 - 90 = 118^\circ$</p>
Q15)	<p>a) $3u \rightarrow 30\text{cm}$ $2u \rightarrow 30 \div 3 \times 2 = 20\text{cm}$ $20 \div 2 = 10$</p> <p>b) <u>Area of..</u> Big quad $\rightarrow \frac{1}{4} \times 3.14 \times 30 \times 30 = 706.5$ $1\frac{3}{4}$ small circle $\rightarrow 549.5$ 3  $\rightarrow 706.5 - 549.5 = 157$ 1  $\rightarrow 157 \div 3 = 52\frac{1}{3}$ Small quad $\rightarrow \frac{1}{4} \times 3.14 \times 10 \times 10 = 78.5$ Total shaded $\rightarrow (52\frac{1}{3} + 78.5) \times 2 \approx 261.7$</p>
Q16)	<p>$5.5u \rightarrow 55$ $32.5 + 17.5 = 50$</p> <p>a) $50u \rightarrow 55 \div 5.5 \times 50 = 500$</p> <p>b) $13u \rightarrow 55 \div 5.5 \times 13 = 130$ $130 \div 10 \times 13 = 169$</p>
Q17)	<p>a) $4u + x = 15p$ $9u - x = 11p$ $36u + 9x = 135p$ $36u - 4x = 44p$ $13x \rightarrow 91p$ $X \rightarrow 7p$ $15p - 7p = 8p$ $4u = 8p$ $9u = 18p$ $18p - 15p = 3p$ $3p \rightarrow 126$ $7p \rightarrow 126 \div 3 \times 7 = 294$ $294 \div 3 = 98$</p> <p>b) $\frac{7}{40}$</p>

