

KYS / AS / TMY / SL / CT

Index No.

						-	
--	--	--	--	--	--	---	--

**SINGAPORE CHINESE GIRLS' SCHOOL**

**PRELIMINARY EXAMINATION 2020**

**PRIMARY 6**

**MATHEMATICS  
PAPER 1**

**BOOKLET A**

Name : \_\_\_\_\_ ( )

Class : Primary 6 SY / C / G / SE / P

18 August 2020

		Marks attained	Max Mark	Parent's Signature
Paper 1	Booklet A		20	
	Booklet B		25	
Paper 2			55	
Total Marks			100	

15 Questions  
20 Marks

Total Time for Booklets A and B: 1 h

**INSTRUCTIONS TO CANDIDATES**

Do not open this booklet until you are told to do so.

Follow all instructions carefully.

Answer all questions.

You are not allowed to use a calculator.

Booklet A

Questions 1 to 10 carry 1 mark each. Questions 11 to 15 carry 2 marks each.

For each question, four options are given. One of them is the correct answer.

Make your choice (1, 2, 3 or 4) and shade your answer on the Optical Answer Sheet.

(20 marks)

---

1. What does the value of the digit 2 in 5.629 stand for?

- (1) 2 ones
- (2) 2 tenths
- (3) 2 hundredths
- (4) 2 thousandths

2. 3817 cm = \_\_\_\_\_ m

- (1) 0.3817 m
- (2) 3.817 m
- (3) 38.17 m
- (4) 381.7 m

3. Which one of the following would be the most likely mass of a watermelon?

- (1) 5 g
- (2) 5 kg
- (3) 50 g
- (4) 50 kg

4. What is the value of  $5k - \frac{3k}{2}$  when  $k = 6$ ?

- (1) 30
- (2) 21
- (3) 12
- (4) 9

5. Which of the following is the same as  $6 + \frac{9}{15}$ ?

(1)  $6 \times \frac{15}{9}$

(2)  $6 \times \frac{9}{15}$

(3)  $\frac{1}{6} \times \frac{9}{15}$

(4)  $\frac{1}{6} \times \frac{15}{9}$

6. Which of the following fractions is larger than  $\frac{1}{5}$ ?

(1)  $\frac{3}{10}$

(2)  $\frac{2}{11}$

(3)  $\frac{3}{15}$

(4)  $\frac{2}{30}$

7. The price of a mobile phone is \$200 excluding GST. GST is 7%.  
What is the price of the mobile phone including GST?

(1) \$14

(2) \$186

(3) \$207

(4) \$214

8. Which of the following figures is not symmetrical?

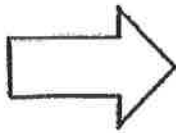

(1)

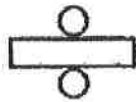

(2)



(3)

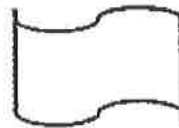

(4)

9. Muthu is at Point X facing North. He turns  $135^\circ$  anti-clockwise. Which direction is he facing now?

- (1) A
- (2) B
- (3) C
- (4) D

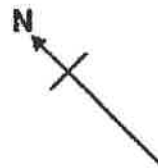
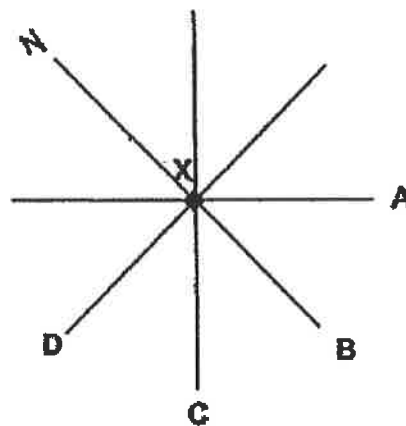

10. Express 143 min in hours and minutes.

- (1) 1 h 23 min
- (2) 1 h 43 min
- (3) 2 h 23 min
- (4) 2 h 43 min

11. In the figure, UTR and QTS are straight lines. SUQR is a trapezium.  
Which of the following statements is false?

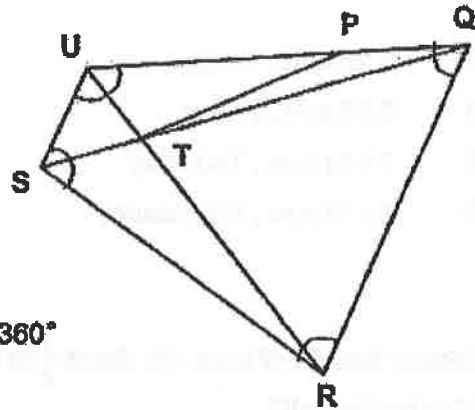

- (1)  $\angle PTU = \angle RTS$  false  
 (2)  $\angle UTS = \angle QTR$   
 (3)  $\angle SUQ + \angle UQR = 180^\circ$   
 (4)  $\angle QRS + \angle RSU + \angle SUQ + \angle UQR = 360^\circ$
12. Mr Raju puts 40 apples into a carton. There are 24 red ones and the rest are green. Find the ratio of the number of green apples to that of the total number of red and green apples.
- (1) 2 : 3  
 (2) 2 : 5  
 (3) 3 : 2  
 (4) 3 : 5
13. Jean bought a speaker and a laptop. She spent \$2000 altogether. The speaker is 4% of the total cost. What is the cost of the laptop?
- (1) \$80  
 (2) \$96  
 (3) \$1920  
 (4) \$1996

14. Tom took a flight from Singapore to London. The journey took 13 h 30 min. He reached London at 12.45 p.m. (Singapore time) on Thursday. At what time and which day did his flight take off from Singapore?

- (1) 2.15 a.m., Friday
- (2) 2.15 p.m., Friday
- (3) 11.15 p.m., Thursday
- (4) 11.15 p.m., Wednesday

15. Jeremy had 7 ℓ of juice. He drank  $\frac{1}{2}$  of it and gave  $\frac{1}{4}$  ℓ to his friend. How much juice had he left?

- (1)  $1\frac{3}{4}$  ℓ
- (2)  $3\frac{1}{4}$  ℓ
- (3)  $6\frac{1}{4}$  ℓ
- (4)  $7\frac{3}{4}$  ℓ

(Go on to Booklet B)

KYS / AS / TMY / SL / CT

Index No.

					-	
--	--	--	--	--	---	--

**SINGAPORE CHINESE GIRLS' SCHOOL**

**PRELIMINARY EXAMINATION 2020**

**PRIMARY 6**

**MATHEMATICS  
PAPER 1**

**BOOKLET B**

Name : \_\_\_\_\_ ( )

Class : Primary 6 SY / C / G / SE / P

18 August 2020

Paper 1	Mark attained	Max Mark
Booklet B		25

15 Questions  
25 Marks

**Total Time for Booklets A and B: 1 h**

**INSTRUCTIONS TO CANDIDATES**

Do not open this booklet until you are told to do so.

Follow all instructions carefully.

Answer all questions.

You are not allowed to use a calculator.





19. Find the volume of a 4-cm cube.

Do not  
in this  
column

Ans: \_\_\_\_\_  $\text{cm}^3$

20. In the figure below, dotted line EF is a line of symmetry. Shade 2 more squares to complete the figure.

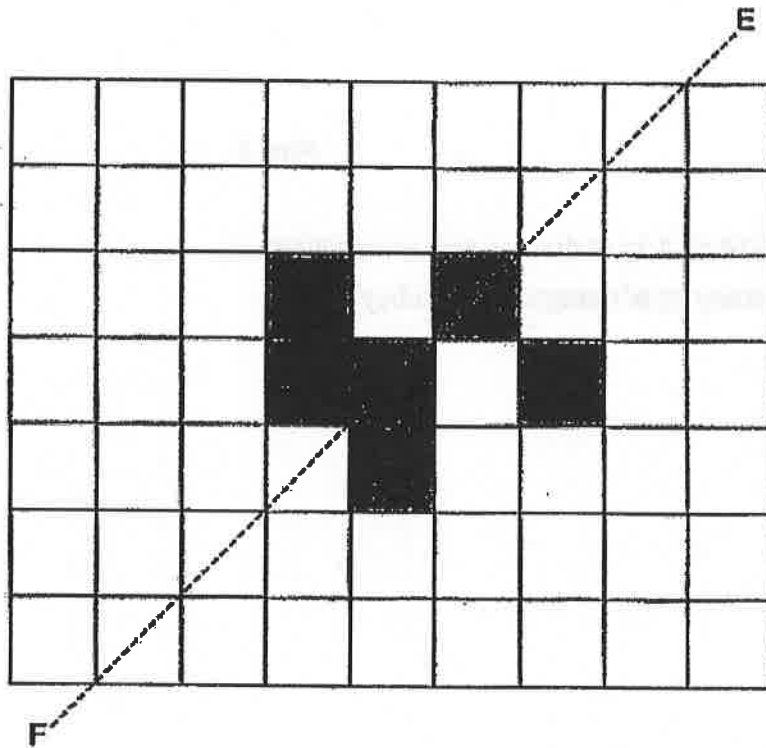

2

Questions 21 to 30 carry 2 marks each. Show your working clearly in the space for each question and write your answers in the space provided. For questions which require units, give your answers in the units stated. (20 marks)

Do not write  
in this  
column

Use the table below to answer questions 21 and 22.

The table below shows prices of durians and mangoes at a fruit stall.

Item	Price per kg
Durian	$\$(m + 14)$
Mango	$\$ m$

21. Peter bought 1 kg of durians and 3 kg of mangoes. How much did he spend? Express your answer in terms of  $m$ .

Ans: \$ \_\_\_\_\_

22. Amara spent \$74 on 1 kg of durians and some mangoes. If  $m = 6$ , how many kg of mangoes did he buy?

Ans: \_\_\_\_\_ kg

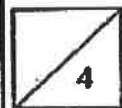

23. The figure below is made up of 2 identical quadrants and 2 semicircles.

$AB = CD = 14$  cm. Find the perimeter of the following figure. (Take  $\pi = \frac{22}{7}$ )

Do not  
in this  
column

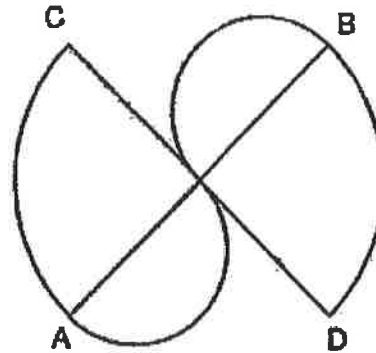

Ans: \_\_\_\_\_ cm

24. Mr Wong bought some green balloons and yellow balloons for his class.

Each of his students used a green balloon and a yellow balloon.

$\frac{2}{5}$  of the green balloons and  $\frac{3}{4}$  of the yellow balloons were left.

What fraction of the total number of balloons did his class use?

Ans: \_\_\_\_\_

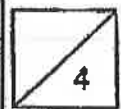

25. Sammy is twice the age of Tim but half that of Ray.  
Given that Ray is 24 years old, what is their average age?

Do not write  
in this  
column

Ans: \_\_\_\_\_

- 
26. A bookshelf can withstand the weight of either 45 small books or 30 big books. Given that it already contained 24 small books and 8 big books, how many more big books can be placed on the bookshelf?

Ans: \_\_\_\_\_

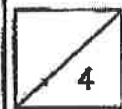

27. The figure is made up of 1 big square, 3 identical small squares and 1 circle.  
 The circle is half the size of a small square.  
 What fraction of the figure is shaded?

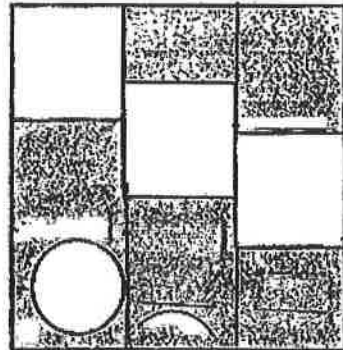

Ans: \_\_\_\_\_

28. Alyssa cut a piece of ribbon into 2 equal pieces. The total length of  $\frac{1}{4}$  of the first piece,  $\frac{2}{3}$  of the second piece is 110 cm. What is the original length of the ribbon?

Ans: \_\_\_\_\_ cm

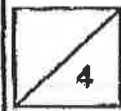

29. The figure below is made up of a parallelogram and triangles.  
 $BH = HG = GF$ ,  $CG$  is 3 times the length of  $GF$ .  
 $BG$  and  $FC$  are straight lines. Given that  $FG = 6$  cm,  
 find the area of the figure.

Do not write  
 in this  
 column

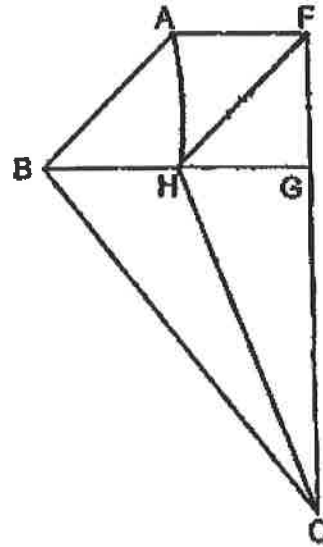

Ans: \_\_\_\_\_  $\text{cm}^2$

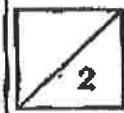

30. Mr Tan and Mr Nordin had some fruits. 40% of Mr Nordin's fruits were oranges and the rest were apples. 80% of Mr Tan's fruits were oranges and the rest were apples.

*Each of the statements below is either true, false or not possible to tell from the information given. For each statement, put a tick (✓) to indicate your answer.*

Statement	True	False	Not possible to tell
Mr Nordin had more apples than oranges.			
Mr Tan had 80 oranges.			
Mr Tan had more oranges than Mr Nordin.			

End of Booklet B



KYS / (AS) / TMY / SL / CT

Index No.

						-	
--	--	--	--	--	--	---	--

**SINGAPORE CHINESE GIRLS' SCHOOL**

**PRELIMINARY EXAMINATION 2020**

**PRIMARY 6**

**MATHEMATICS**

**PAPER 2**

Name : \_\_\_\_\_ ( )

Class : Primary 6 SY / C / G / SE / P

18 August 2020

	Mark	Max Mark
<b>Paper 2</b>		<b>55</b>

Parent's Signature

**17 Questions**  
**55 Marks**

**Total Time for Paper 2: 1 h 30 min**

**INSTRUCTIONS TO CANDIDATES**

Do not open this booklet until you are told to do so.

Follow all instructions carefully.

Answer all questions.

You are allowed to use the calculator.



Questions 1 to 5 carry 2 marks each. Show your working clearly in the space below each question and write your answers in the spaces provided. For questions which require units, give your answers in the units stated. (10 marks)

Do not write  
this column

- 1 Amy and Bala have 275 beads. If Amy gives Bala 20 beads, Bala will have 10 times as many beads as Amy. How many beads does Amy have?

Ans: \_\_\_\_\_

- 2 A farmer had some apples. She gave 1200 apples to her friend and  $\frac{3}{8}$  of the remainder to her aunt. She had 150 apples left. How many apples did she have at first?

Ans: \_\_\_\_\_

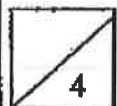

3. A machine takes  $\frac{1}{6}$  of a minute to assemble a phone. How many phones can it assemble in 5 minutes?

Ans: \_\_\_\_\_

- 
4. Allison's watch is programmed to ring every 5 minutes. Her alarm clock is programmed to ring every 8 minutes. At what time will the 2 devices ring together again given that the last time they rang together was at 10 a.m.?

Ans: \_\_\_\_\_

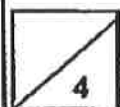

5. In the figure below,  $FHG$  is an isosceles triangle.  $EFG$  is a straight line. Find  $\angle DFH$ .

Do not write in this column

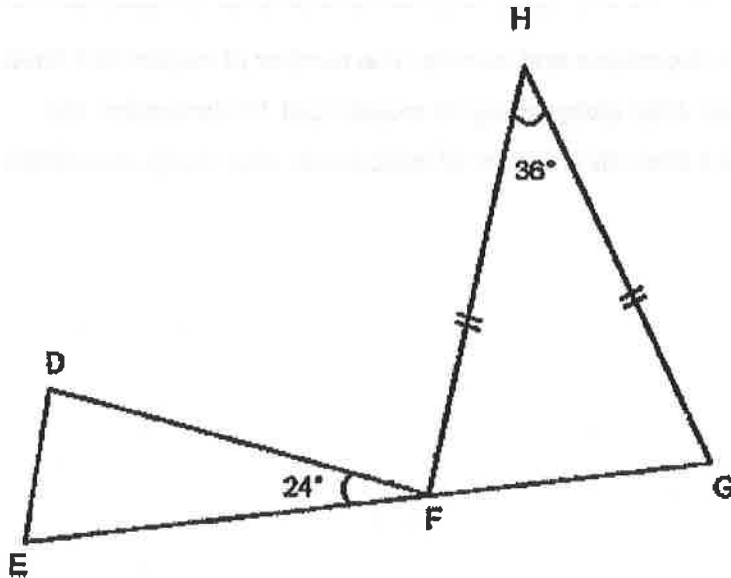

Ans: \_\_\_\_\_

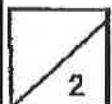

For questions 6 to 17, show your working clearly in the space below each question and write your answers in the spaces provided. The number of marks awarded is shown in brackets [ ] at the end of each question or part-question. (45 marks)

6. Tiffany bought some chocolates and sweets. The number of sweets is 3 times the number of chocolates. After giving away 10 sweets and 10 chocolates, the number of sweets is 5 times the number of chocolates. How many chocolates did she buy?

Ans: \_\_\_\_\_ [3]

7. Mr Lim has big pieces of wood measuring 12.5 m each. He cuts the wood into smaller pieces measuring 30 cm each. He needs 290 small pieces of wood to build a fence. What is the least number of big pieces of wood he needs to build the fence?



Ans: \_\_\_\_\_ [3]

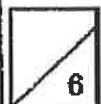

8. Sandra has some lemon and peppermint sweets in a container.  $\frac{3}{5}$  of the sweets are peppermint. After she adds in another 30 peppermint sweets,  $\frac{3}{4}$  of the sweets are peppermint. How many sweets does she have in the container in the end?

Do not write  
this column

Ans: \_\_\_\_\_ [3]



9.

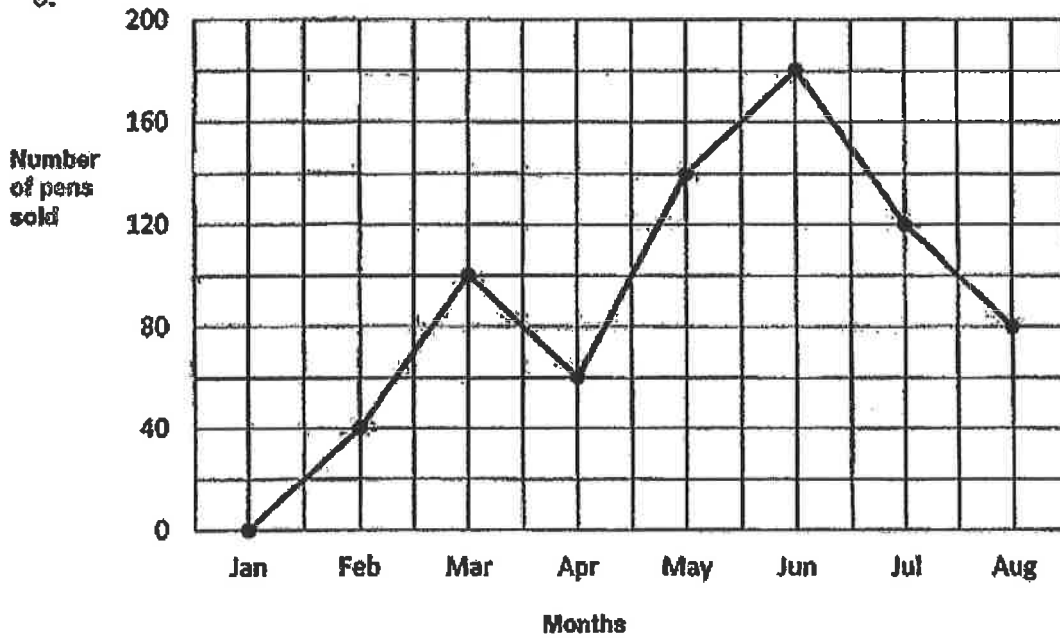

The graph above shows the number of pens sold in a shop.

- The greatest increase in sales happened during which one-month period?
- Find the percentage decrease from June to July.

Ans: a) \_\_\_\_\_ to \_\_\_\_\_ [1]

b) \_\_\_\_\_ [2]

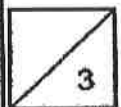

10. Painter A takes 2 h to paint a room. Painter B takes 3 h to paint the same room. How long will they take if they were to paint the room together?

Do not write  
in this column



Ans: \_\_\_\_\_ [3]

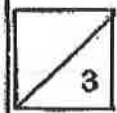

11. ABCD is a rhombus. DCGF is a trapezium. DEF is an isosceles triangle.  
Find  $\angle x$ .

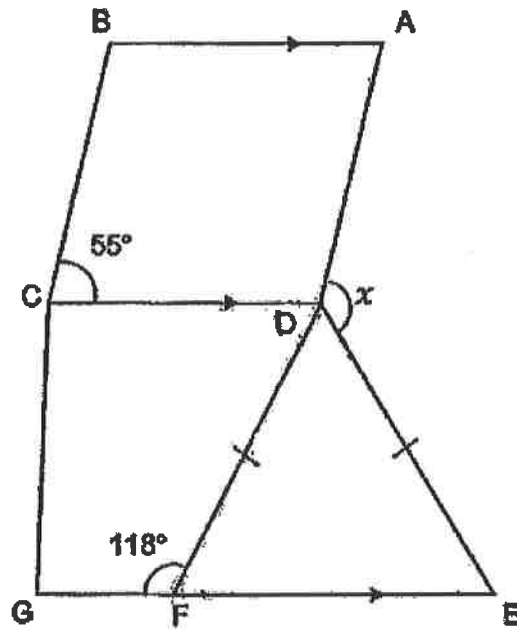

Ans: \_\_\_\_\_ [4]

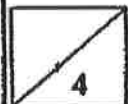



12. A bag of kiwis was shared among 3 children, Xavier, Yanny and Zara. Xavier received 40% of the kiwis plus 2 more. Yanny received 50% of the remainder plus 8 more. If Zara received 54 kiwis, how many kiwis were in the bag at first?

Do not write  
this column



Ans: \_\_\_\_\_ [4]



13. Tables and chairs are arranged in the figures below.



Figure 1



Figure 2

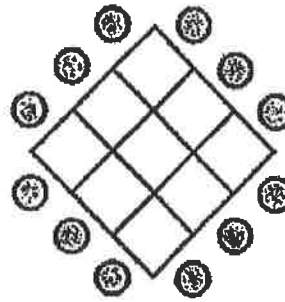

Figure 3

a) Complete the table below.

Figure	Number of tables (squares)	Number of chairs (circles)	Total
1	1	4	5
2	4	8	12
3	9	12	21
4			

[3]

b) What is the total number of tables and chairs needed to form Figure 39?

Ans: b) \_\_\_\_\_ [2]

5

14. The solid below is made up of 1-cm cubes stacked together.

Do not write  
this column

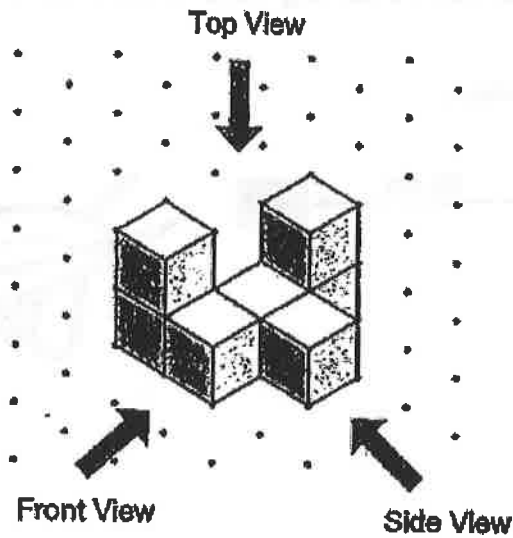

a) Draw the top and front view of the solid on the grid below.

Top View

Front View

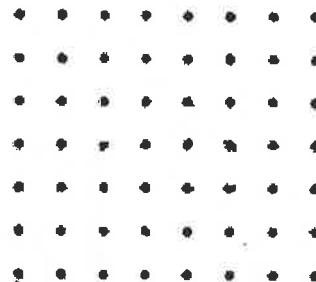
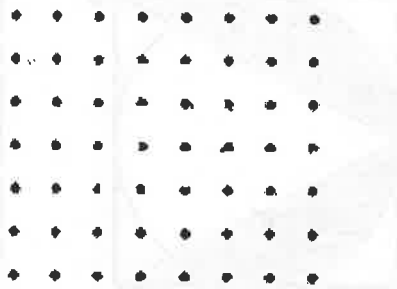

[2]

b) From the diagram as shown above, how many more 1-cm cubes are needed to form a 5-cm cube?

Ans: \_\_\_\_\_ [2]

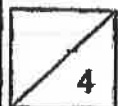

15 a) A part of the wheel of a wheelbarrow was coated with paint as shown in the diagram. The diagram below showed the marking made by the wheel when it moved through a distance.

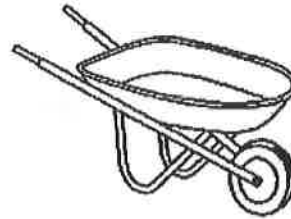
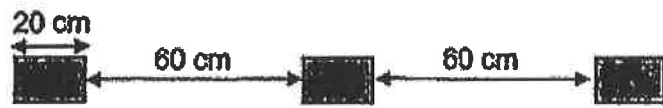

15 b) PQRS is a square. T is the mid-point of PS.  $TQ = TR$ .

Find the area of the shaded parts. (Take  $\pi = 3.14$ )

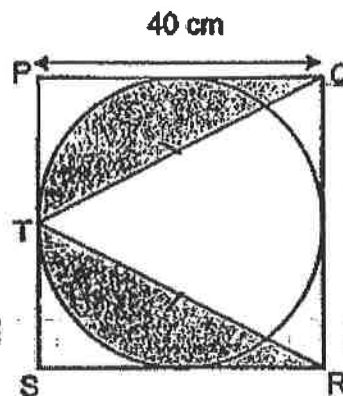

Ans: a) \_\_\_\_\_ [2]

b) \_\_\_\_\_ [3]

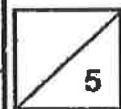

16 A plate of chicken rice cost \$4 while a plate of spaghetti cost \$7. Miss Tan ordered plates of chicken rice and spaghetti in the ratio 2 : 5 for her pupils in a camp. She paid \$258 in total.

Do not write  
this column

- a) How many plates of chicken rice did she order?
- b) How much more money did she spend on spaghetti than chicken rice?

Ans: a) \_\_\_\_\_ [2]

b) \_\_\_\_\_ [2]



17. The figure below is made up of a rectangle and triangles. The area of the quadrilateral BFGI is  $21 \text{ cm}^2$ . Find the area of the shaded part.

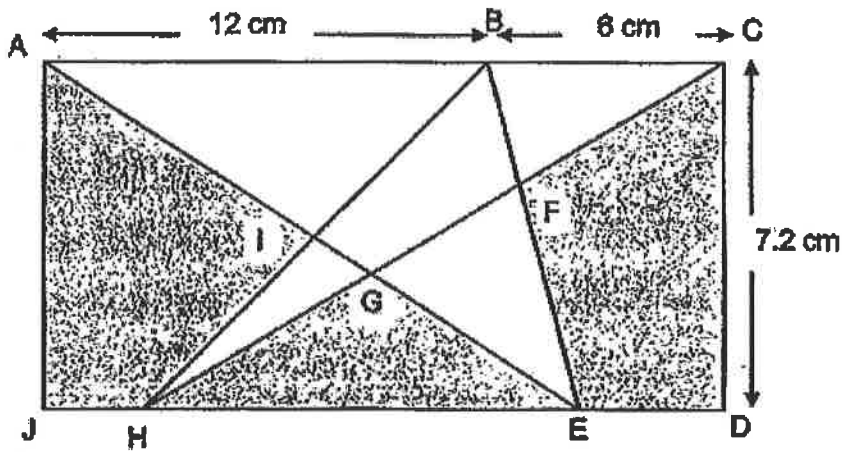

Ans: \_\_\_\_\_ [4]



End of Paper

SCHOOL : SCGS PRIMARY SCHOOL  
 LEVEL : PRIMARY 5  
 SUBJECT : MATH  
 TERM : 2020 PRELIM

**PAPER 1 BOOKLET A**

Q 1	Q2	Q3	Q4	Q5	Q6	Q7	Q8	Q9	Q10
3	3	3	2	1	1	4	4	3	3

Q 11	Q12	Q13	Q14	Q15
1	2	3	4	2

**PAPER 1 BOOKLET B**

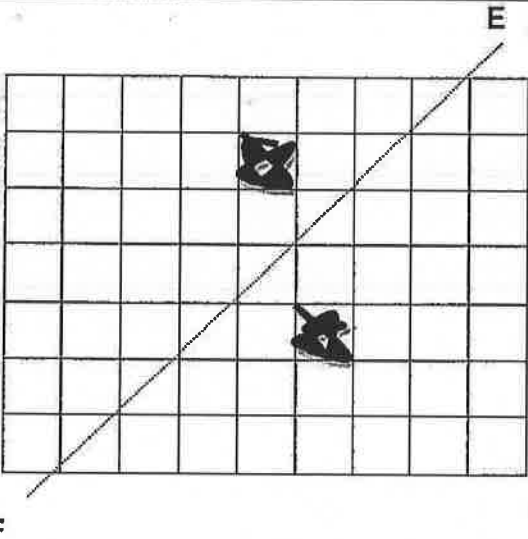
Q16)	6
Q17)	400
Q18)	1, 5
Q19)	64 cm <sup>3</sup>
Q20)	

Q21)	Mango $\rightarrow \$m \times 3 = \$3m$ Durian $\rightarrow \$(m + 14)$ Total $\rightarrow \$3m + \$(m + 14)$ $= \$ (4m + 14)$
Q22)	$\$74 - \$20 = \$54$ $\$54 \div \$6 = 9\text{kg}$
Q23)	Circumference $\rightarrow \frac{1}{4} \times \frac{22}{7} \times \frac{14}{1} = 11\text{cm}$  Circumference $\rightarrow \frac{1}{2} \times \frac{22}{7} \times \frac{7}{1} = 11$  $11 \times 4 = 44$ $7 \times 2 = 14$ $44 + 14 = 58$
Q24)	$\frac{3}{5} + \frac{1}{4}$ $= \frac{3}{5} = \frac{3}{12}$ $= \frac{6}{17}$
Q25)	$4u \rightarrow 24$ $1u \rightarrow 24 \div 4 = 6$ $7u \rightarrow 6 \times 7 = 42$ Average $\rightarrow 42 \div 3 = 14$
Q26)	6
Q27)	$\frac{7}{18}$
Q28)	1 <sup>st</sup> piece $\rightarrow \frac{1}{4} = \frac{3}{12}$ 2 <sup>nd</sup> piece $\rightarrow \frac{2}{3} = \frac{8}{12}$ $3u + 8u = 11u$ $11u \rightarrow 110$ $24u \rightarrow \frac{110}{11} \times 24 = 240 \text{ cm}$
Q29)	A $\rightarrow 6 \times 6 = 36$ D $\rightarrow 6 \times 6 \times \frac{1}{2} = 18$ C+B $\rightarrow 12 \times 18 \times \frac{1}{2} = 108$ A+D+C+B $\rightarrow 36 + 18 + 108 = 162 \text{ cm}^2$



Q30)		True	False	Not possible to tell
	Mr Nordin had more apples than oranges	✓		
	Mr Tan had 80 oranges			✓
	Mr Tan had more oranges than Mr Nordin			✓

## PAPER 2

Q1)	$10u + 1u = 11u$ $1u \rightarrow 275 \div 11 = 25$ $25 + 20 = 45$
Q2)	$5u \rightarrow 150$ $1u \rightarrow 150 \div 5 = 30$ $8u \rightarrow 30 \times 8 = 240$ At first $\rightarrow 240 + 1200 = 1440$
Q3)	10 seconds $\rightarrow$ 1 phone 60 seconds $\rightarrow$ 6 phones 1min $\rightarrow$ 6 phones 5 mins $\rightarrow 6 \times 5 = 30$
Q4)	10 40 a.m.
Q5)	$180^\circ - 36^\circ = 144^\circ$ $144^\circ \div 2 = 72^\circ$ $180^\circ - 72^\circ - 24^\circ = 84^\circ$
Q6)	$1u \rightarrow 10$ $2u \rightarrow 10 \times 2 = 20$
Q7)	$12.5m = 1250cm$ $1250 \div 30 \approx 41$ $290 \div 41 \approx 8$

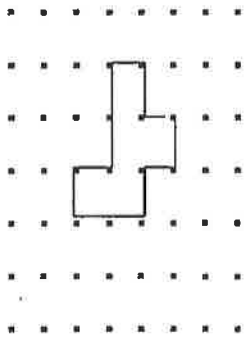
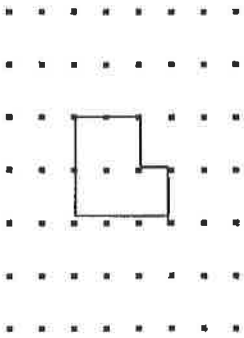
Q8)	$3u \rightarrow 30$ $1u \rightarrow 30 \div 3 = 10$ $8u \rightarrow 10 \times 8 = 80$
Q9)	a) April to May b) $\frac{60}{180} \times 100\% = 33\frac{1}{3}\%$
Q10)	5 rooms $\rightarrow$ 6 hours 1 room $\rightarrow$ 1.2 hours 1.2 hours = 1h 12 mins
Q11)	$360^\circ - 55^\circ - 55^\circ = 250^\circ$ $250^\circ \div 2 = 125^\circ$ $180^\circ - 118^\circ = 62^\circ$ $180^\circ - 62^\circ - 62^\circ = 56^\circ$ $\angle X \rightarrow 360^\circ - 62^\circ - 125^\circ - 56^\circ = 117^\circ$
Q12)	50% $\rightarrow 8 + 54 = 62$ 100% $\rightarrow 62 \times 2 = 124$ Total 60% $\rightarrow 124 + 2 = 126$ 100% $\rightarrow \frac{126}{60} \times 100 = 210$
Q13)	a) 16, 16, 32 b) $39 \times 39 = 1521$ circles $\rightarrow 39 \times 4 = 156$ Total $\rightarrow 1521 + 156 = 1677$
Q14)	a) <div style="display: flex; justify-content: space-around; align-items: center;"> <div style="text-align: center;">  </div> <div style="text-align: center;">  </div> </div> b) $5 \times 5 \times 5 = 125$ $125 - 7 = 118$

Q15)	<p>a) <math>20\text{ cm} + 60\text{ cm} = 80\text{ cm}</math>  b) Area of A <math>\rightarrow \frac{1}{2} \times 40\text{cm} \times 40\text{cm} = 800\text{cm}^2</math>  square <math>\rightarrow 40\text{cm} \times 40\text{cm} = 1600\text{cm}^2</math>  circle <math>\rightarrow 3.14 \times 20\text{cm} \times 20\text{cm} = 1256\text{cm}^2</math>  <math>1600\text{cm}^2 - 1256\text{cm}^2 = 344\text{cm}^2</math>  <math>344\text{cm}^2 \div 4 = 86\text{cm}^2</math>  Shaded <math>\rightarrow 1600\text{cm}^2 - 86\text{cm}^2 - 86\text{cm}^2 - 800\text{ cm}^2 = 628\text{cm}^2</math></p>
Q16)	<p>Chicken : spaghetti  2 : 5</p> <p>1set <math>\rightarrow (2 \times 4) + (5 \times 7) = 43</math>  No. of sets <math>\rightarrow 258 \div 43 = 6</math>  Plates of chicken rice <math>\rightarrow 6 \times 2 = 12</math>  Plates of spaghetti <math>\rightarrow 6 \times 5 = 30</math>  Diff <math>\rightarrow (30 \times 7) - (12 \times 4) = 162</math></p>
Q17)	<p>Area ACDJ <math>\rightarrow 18 \times 7.2 = 129.6</math>  Area DABC <math>\rightarrow \frac{1}{2} \times 12 \times 7.2 = 43.2</math>  Area ABCH <math>\rightarrow \frac{1}{2} \times 6 \times 7.2 = 21.6</math>  Unshaded <math>\rightarrow 43.2 + 21.6 - 21 = 43.8</math>  Shaded <math>\rightarrow 129.6 - 43.8 = 85.8\text{cm}^2</math></p>

